

YMC EcoPrime® Caustic Dilution Systems

From simple point-of-use to complex centralized distribution

- Simplified, on-demand process
- Dilute up to 50% caustic
- Wide dilution range
- Wide capacity and flow rate
- Optional temperature control
- Compact footprint



System shown for illustrative purposes only. System supplied may differ.

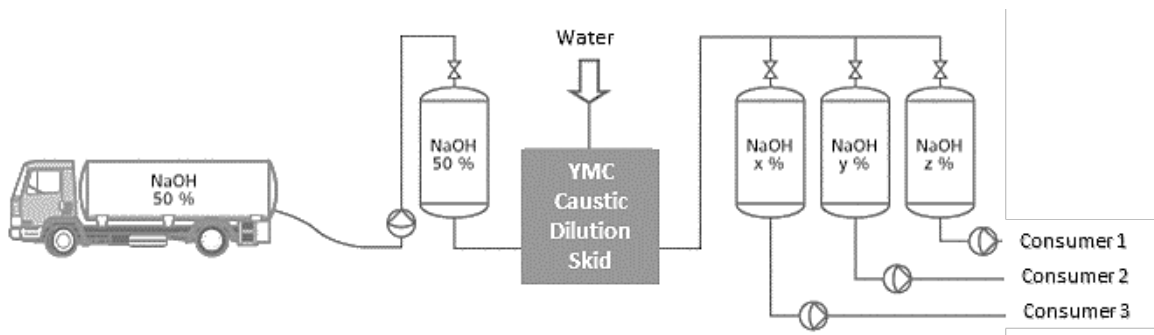

In-line Caustic Dilution Reduces Cost and Improves Flexibility

Multiple, pre-engineered configurations meet your process needs.

Sodium hydroxide is a widely accepted cleaning and sanitization agent for bioprocessing equipment and chromatography media. It is also used for pH adjustment in many processes. Sodium hydroxide is not only very effective, it is also low cost and easy to detect using pH and conductivity measurements to ensure it has been removed. Dilute caustic solutions are recommended as short-term equipment storage solutions to prevent bacterial growth.

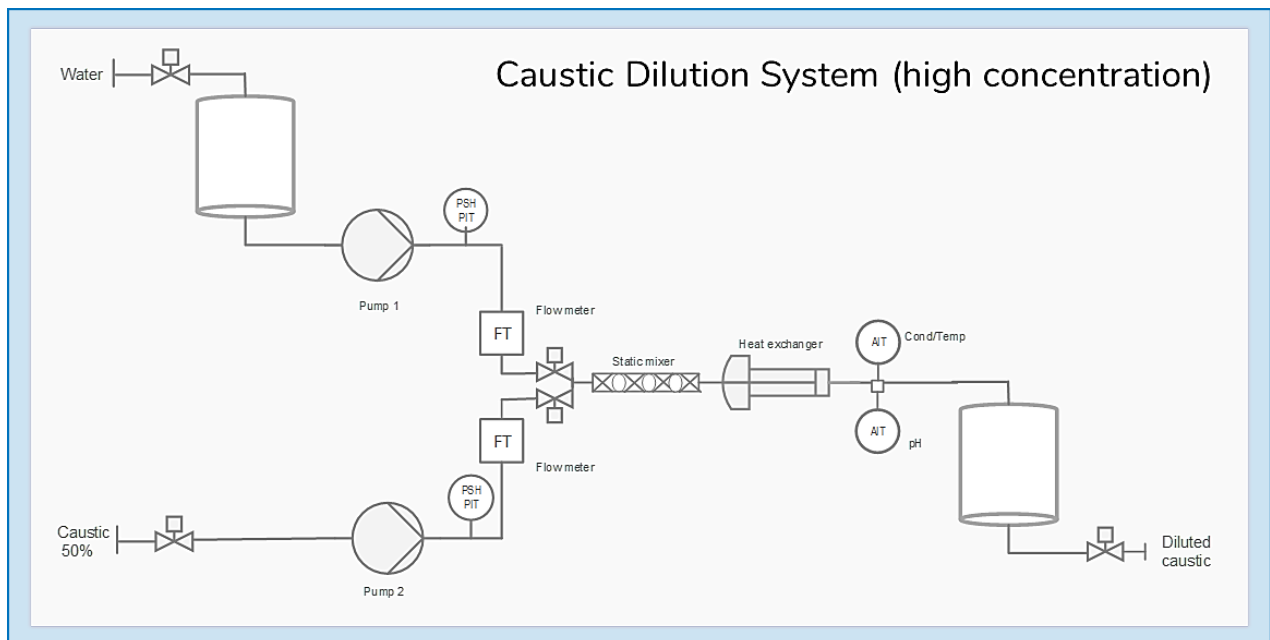
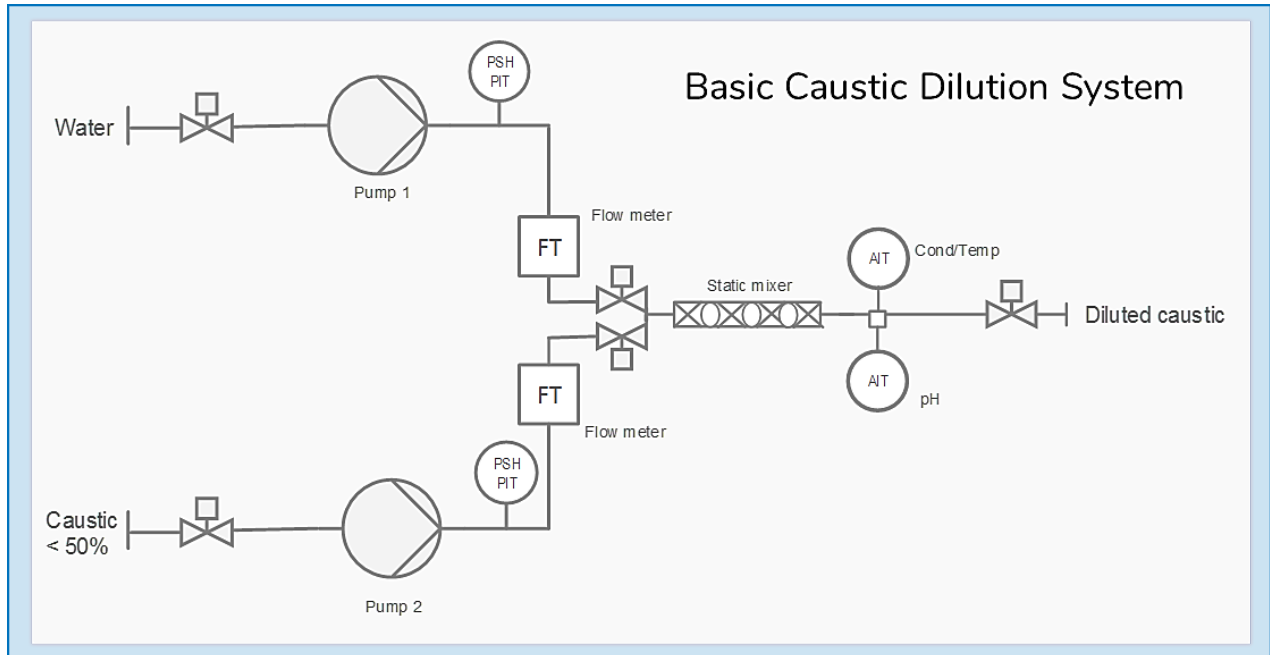

In-line Caustic Dilution Benefits

- Saves time and money
- Allows flexibility in scheduling
- Reduces dependence on supplier
- Minimizes operator exposure risk

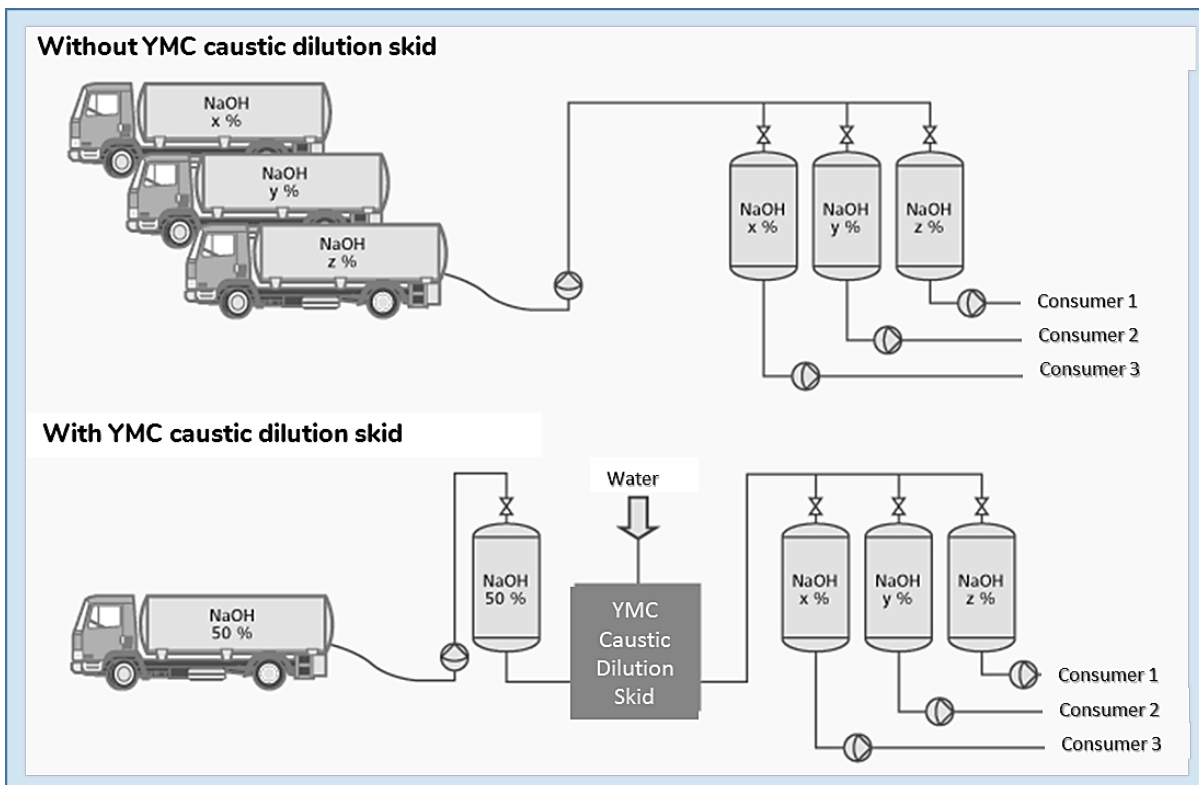
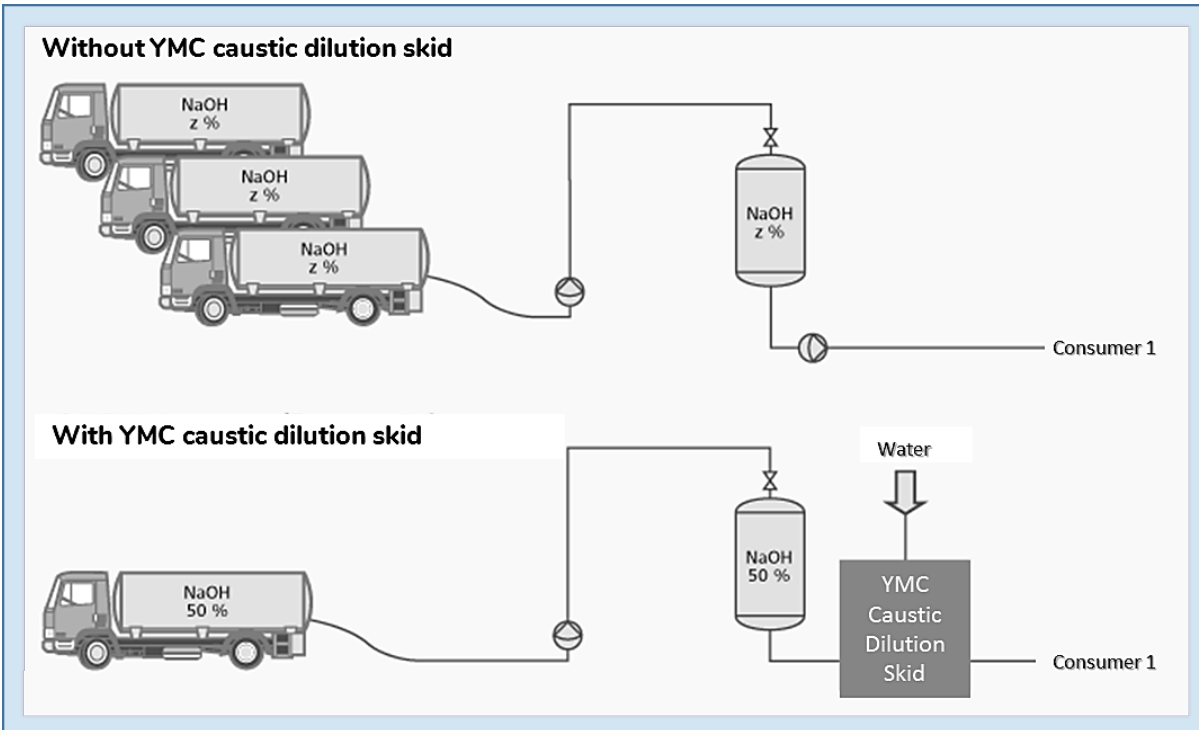

Typical analytical ranges for in-line caustic dilution

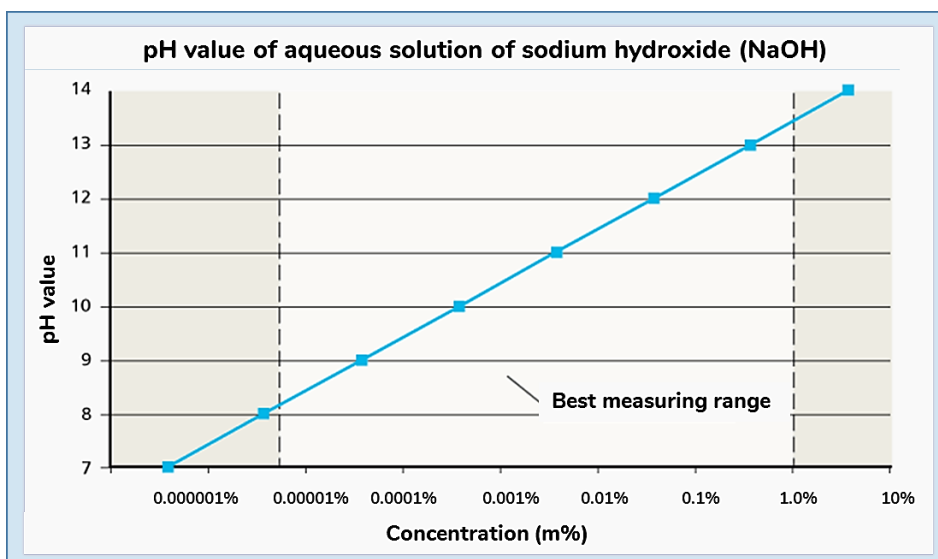
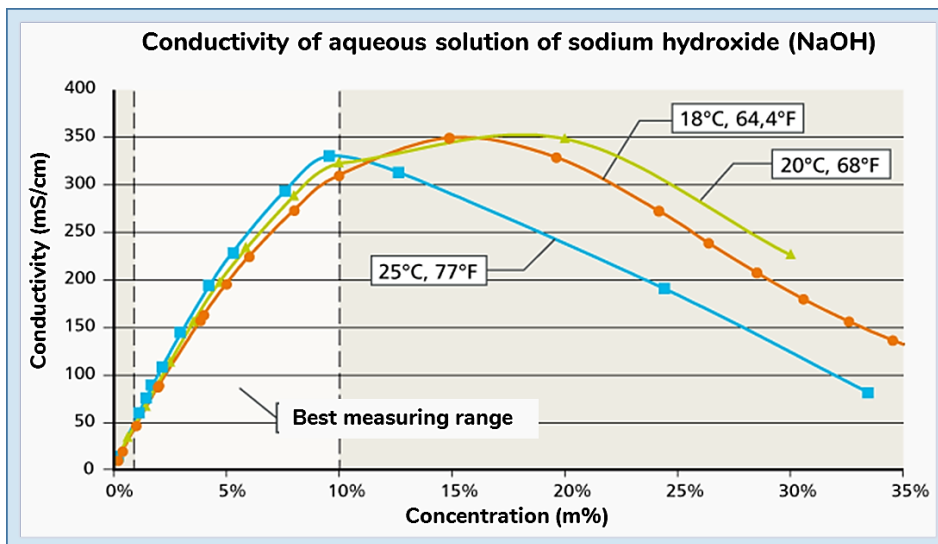
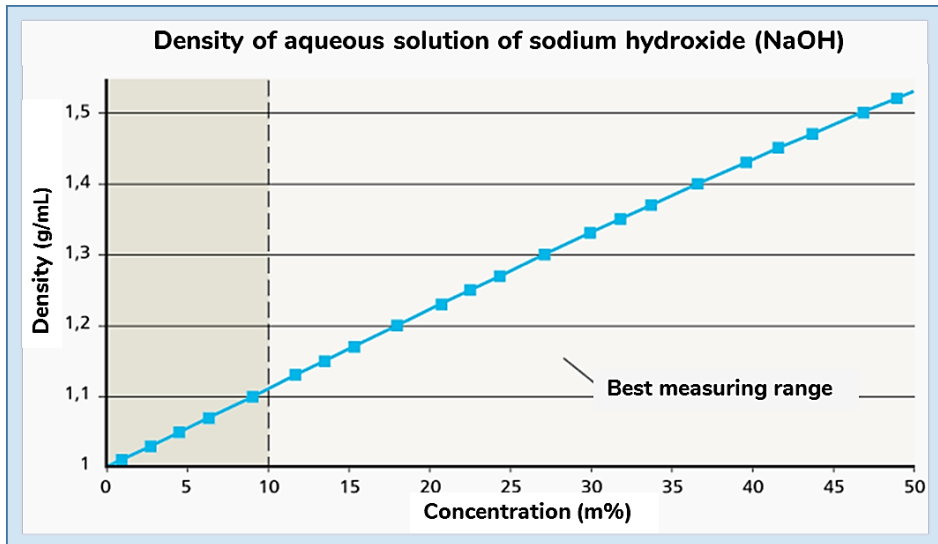

YMC EcoPrime In-line Caustic Dilution System

Delivers consistent, point-of-use caustic solutions.

Best-in-class design

YMC in-line caustic dilution systems are designed to perform the highly controlled caustic dilution process managing the exothermic reaction and preventing precipitation. The system consists of digitally-controlled metering pumps and sensors to monitor the process and an optional heat exchanger and break tanks to manage excess heat. System software and automation allows the user to configure and run recipes that precisely prepare diluted, ready-to-use caustic solutions.

- Automatically prepares accurate and precise caustic solutions at point-of-use or central location.
- Enables dilution of up to 50% sodium hydroxide.
- Robust and simple dilution based on control with volumetric flow rate to ensure consistent composition.
- Fluidic design that facilitates mixing, reduces time required to reach set points, and enables drainability.
- User adaptable software that is recipe-driven with configurable, pre-programmed sequences that minimizes operator intervention.

Volumetric flow control based buffer dilution

Digitally-controlled, metering pumps deliver precise and accurate flow of both concentrate and diluent across a wide flow rate range assuring better control of final composition and minimizing variation of critical quality attributes (concentration, conductivity, and pH). This straightforward process control reduces the need for in-process adjustments facilitating validation.

Quality and regulatory considerations

As with all YMC bio/pharmaceutical equipment, the EcoPrime caustic dilution system is designed to meet high quality expectations. The system materials of construction are compatible with long-term caustic exposure. The design and construction of the equipment meets the following standards, assuring a safe, ergonomic system capable of producing the product within the guidelines of the FDA:

- System designed for GMP operation and validation
- Enables 21 CFR part 11 compliance
- USP Class VI materials
- Compliance to ASME-BPE
- CE conformity

EcoPrime In-line Caustic Dilution delivers the following process benefits

- Limited requirement for tanks, less footprint
- Less operator exposure to potential chemical hazards
- Reduced labor costs
- Increased process scheduling flexibility
- More independence from supplier quantities
- Reproducible and accurate caustic solutions with volumetric flow control
- Reduced CIP volume and waste, leaner operation
- Compatible with single use assemblies
- Automation available as a stand-alone “island” or (optional) integrated into central plant SCADA architecture.

The future provides broader solutions for our customers

The innovation and growth of this and other EcoPrime product lines has attracted the attention of leading technology suppliers and users. YMC Co., Ltd. assumed all rights and production for the EcoPrime suite of systems in late 2018 from LEWA-Nikkiso America, Inc. This acquisition brings a broad spectrum of chromatographic resins, and columns ideal for large and small molecule purification. More about this new chapter for EcoPrime at www.ymcpt.com.



Ordering information

To order the EcoPrime Caustic Dilution system, please contact your regional sales representative.

YMC Process Technologies
Bio/Pharma Systems' Group
8 Charlestown Street
Devens, MA 01434
Tel: +1 978 487 1100
www.ymcpt.com
sales@ymcpt.com

Headquarters: YMC Co., Ltd.
YMC Karasuma-Gojo Building
284 Daigo-cho, Karasuma Nishiiru,
Gojo-dori,
Shimogyo-ku, Kyoto, 600-8106 Japan
Tel: +81-75-342-4515
FAX: +81-75-342-4550
www.ymc.co.jp
sales@ymc.co.jp

Regional Offices:
www.ymcamerica.com
www.ymc-europe.com
www.india.com
www.ymchina.com
www.ymckorea.com
www.ymc.sg.com
www.ymctaiwan.com

YMC logo is a trademark of YMC Co. Ltd.

Rockwell FactoryTalk is a registered mark of Rockwell Automation.
DeltaV is a registered mark of the Emerson Process Management family of companies.

All goods and services are sold subject to the terms and conditions of sale of the company within YMC which supplies them. A copy of these terms and conditions is available on request. Contact your local YMC representative for the most current information.

Subject to change without notice. Data herein does not constitute a guarantee of performance.

© 2018 YMC Process Technologies. – All rights reserved.